

J.P. SAUER & SOHN
ESTABLISHED 1751



CATALOGUE
GUNS FOR GENERATIONS



SAUER & SOHN.
PART OF YOUR FAMILY.



CONTENTS

Editorial	04
New Products	06
Sauer Artemis	10
Sauer Carbon	14
Sauer ATELIER 1751	16
<hr/>	
Sauer 404	28
Sauer 101	46
Sauer 100	64
Sauer 303	74
Sauer Shotguns	84
Sauer Accessories	90
Technical Specifications	112

THE WORLD'S MOST
BEAUTIFUL HUNTING
RIFLES SINCE ...

1751

...

Our rifles have been inspiring generations of hunters for almost three centuries.
We are proud of this.

EIGHT GENERATIONS
JOY OF HUNTING





**J.P. SAUER & SOHN –
finest gunmaking for more than 270 years**

Since its founding in 1751, J.P. SAUER & SOHN has stood for timeless elegance and uncompromising quality. As Germany's oldest hunting rifle manufacturer, we have inspired generations of hunters for whom their own rifle is more an expression of their personality than a simple tool. This enthusiasm has always spurred our gunsmiths on to top performance.

Aware that they are part of an entrepreneurial success story and with a passion that can only be developed by gunsmiths who see their craft as a vocation, they create rifles that are second to none.

PLEASURE AND PRIDE
YOU CAN ENJOY ALONE
OR PASS ON TO
NEXT GENERATIONS.

Hunting rifles from J.P. SAUER & SOHN are an expression of a living hunting culture. Numerous German hunters' households own at least one rifle made by Sauer, which already inspired the grandparents and is passed on to the parents' generation or the grandchildren. Thus, a Sauer hunting rifle never belongs only to the person who acquires it, but his descendants will certainly still enjoy it. One more token that Sauer rifles are not a contemporary phenomenon, but rifles for generations.

Waidmannsheil,

Julian Wengenmayr
CEO J.P. SAUER & SOHN

J.P. SAUER & SOHN
ESTABLISHED 1751

J.P. SAUER & SOHN NEW PRODUCTS

Values like tradition, cohesion and a sense of family will always be relevant, however long they may exist. They are in no way contradictory to progress, further development and innovation, but inspire and anchor in equal measure. That's why we, of course, also move with the times – and have added the latest developments in gunmaking to our portfolio.





SAUER 100 ARTEMIS

Optimised for the huntress: This rifle has everything a modern hunting rifle needs. Timeless beauty included.

LEARN MORE ON PAGE 68



SAUER 101 ARTEMIS ELEGANCE

Uncompromising beauty: All features of the Artemis line in its most beautiful form. Compact, ergonomic, elegant.

LEARN MORE ON PAGE 54



SAUER 101 ELEGANCE

Elegance to perfection: Boasting elegant walnut, a red recoil pad and a jeweled bolt, this rifle embodies all core values of the Sauer brand.

LEARN MORE ON PAGE 58



SAUER 101
HIGHLAND XTA

Ultra tough and at the same time lightweight rifle for the active hunter – with DLC coating and polymer stock with soft touch.

LEARN MORE ON PAGE 62



SAUER 101
SILENCE GTI

Incredibly good, perfectly balanced: Ergonomic laminated stock with height-adjustable comb and integral silencer with barrel and silencer jacket made of titanium.

LEARN MORE ON PAGE 50



SAUER 404
SILENCE XTC

Lightweight and silent: Integral silencer with barrel and silencer jacket made of titanium and carbon thumbhole stock provide optimum balance and minimise recoil.

LEARN MORE ON PAGE 42



A WOMAN'S WEAPON

Named after the greek goddess of hunting, developed from huntresses for huntresses, built by Sauer – that is how the product line Artemis can be described in a few words.

Strong, brave and confident – these are huntresses of today. They not only set high standards for their hunting skills, but also to their choice of equipment.

For the Sauer Artemis line, we developed and optimised the stock together with women, ensuring to focus on achieving intuitive and precise shooting in all conditions. From the S404, the S100 and S101 to the S303, female hunters appreciate the timeless elegance of their Sauer Artemis. Numerous enhancements give the Artemis models their individual touch. A new generation of rifles for women!



- A Pistol grip optimised for female hands.
- B Two centimetres shorter distance between pistol grip and trigger blade for optimum trigger control.
- C Shorter buttstock.
- D The height-adjustable comb ensures that the sighting line (E) fits instantly when aiming intuitively.

SAUER ARTEMIS

For our Artemis line, we have not only optimised the stock dimensions, but have also completely redesigned the Artemis collection. The entire stock is geometry based focusing on the female body dimensions.

Among other enhancements, we have created a sleeker pistol grip and also shortened the distance between the pistol grip and the trigger blade by two centimetres, which suits women's petite hands much better.



J.P. SAUER & SOHN
ESTABLISHED 1751

HIGHTECH HANDCRAFT

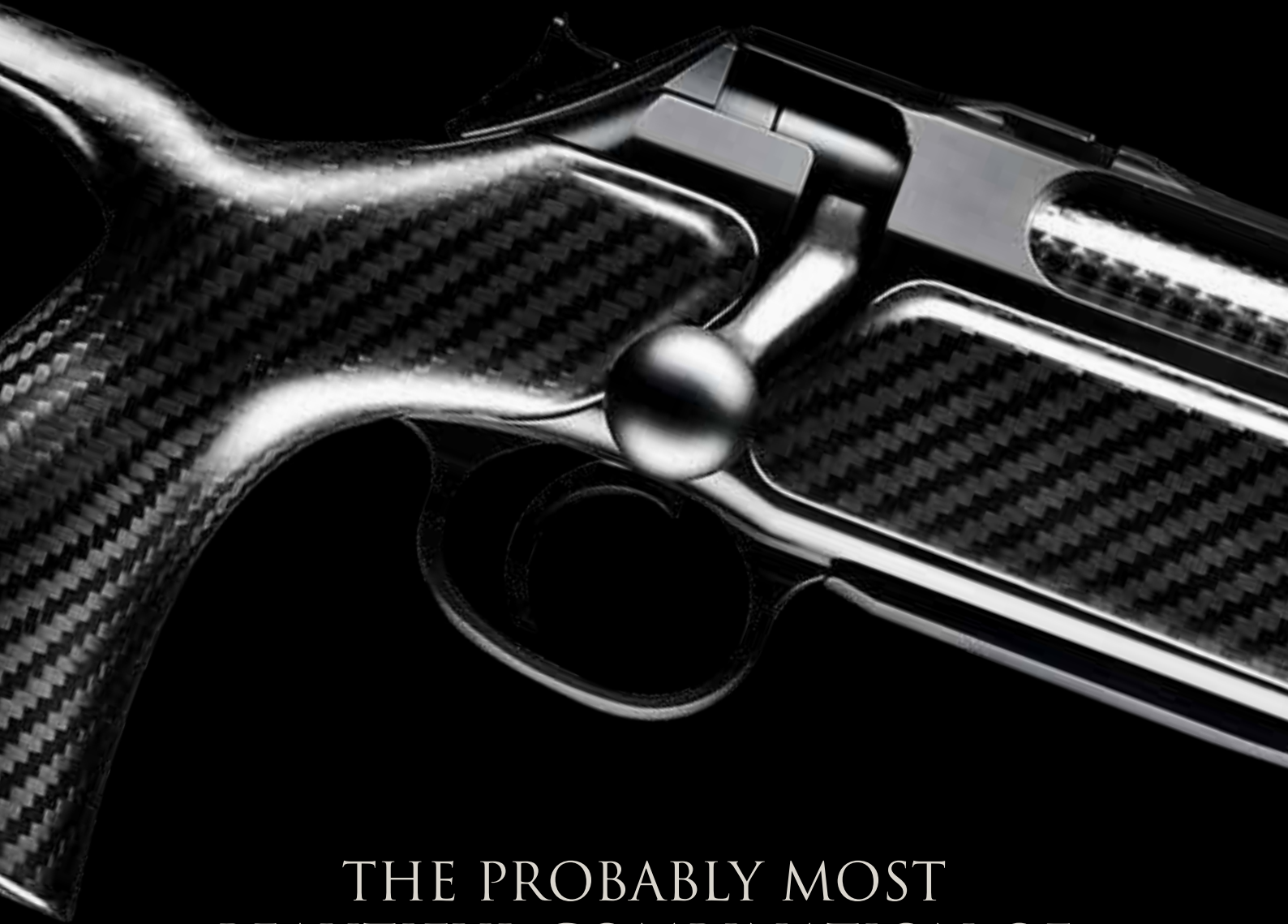

THE PROBABLY MOST
BEAUTIFUL COMBINATION OF
TRADITION AND INNOVATION:
SAUER XTC



SAUER 404 SYNCHRO XTC

High-tech meets ergonomics: The Synchro XTC perfectly combines the benefits of carbon and thumbhole stock.

LEARN MORE ON PAGE 40



SAUER 404 SILENCE XTC

Lightweight and silent: Integral silencer with barrel and silencer jacket made of titanium and carbon thumbhole stock provide optimum balance and minimise recoil.

LEARN MORE ON PAGE 42



SAUER 101 HIGHLAND XTC

Reduced to the essential:
The S101 Highland XTC is made for hardest use.

LEARN MORE ON PAGE 60

ATELIER 1751



J.P. SAUER & SOHN
ESTABLISHED 1751

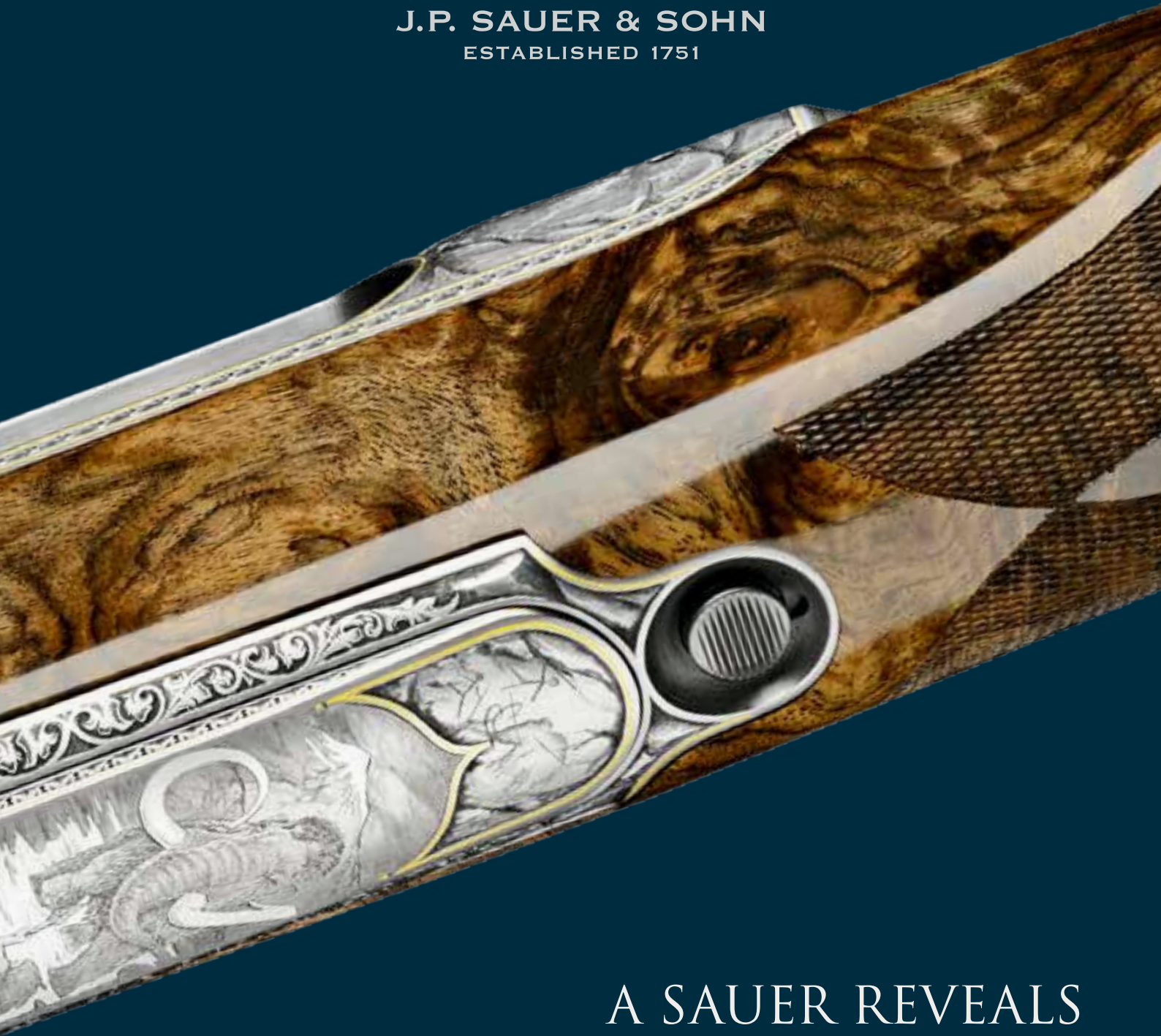

A SAUER REVEALS
ITSELF SO VALUABLE
TO ITS OWNER THAT IT
NEVER LEAVES THE FAMILY.

A bolt action rifle from J.P. SAUER & SOHN cannot be made technically better. But every rifle can become a personality. True to this motto, the ATELIER 1751 of J.P. SAUER & SOHN knows no bounds of imagination and design when it comes to your individually manufactured rifle.



SAUER 404 – “STONE AGE”

A tribute to the hunters of the Stone Age, which brings hunting scenes for mammoths to life in an almost three-dimensional effect by the hand of master engraver Hendrik Frühauf.

This was achieved by combining numerous engraving techniques: From inlaid gold and silver sections to modelled landscapes, ornamentation and feather engravings. A fine gold thread was inlaid in the case of the “Stone Age” as well as in the magazine base. Tusks of the mammoths were accentuated by alloyed silver inlays. Fine parts, such as the hair of the mammoths, small stones or small cracks that appear on the rocks were engraved using feather engraving techniques.

The crowning element is the scrimshaw of a Stone Age hunting scene at the end of the buttstock, as well as the pistol grip cap with inlaid ammonite, which in turn is surrounded by a scrimshaw in the style of Stone Age cave paintings. All of this – just like the bolt knob – is of course made of genuine mammoth ivory.





SAUER 404 AVANTGARDE GRANDE LUXE

Whether it is a personally selected wooden stock, an individually designed bolt knob, a personalised barrel root ring or special engravings on the receiver, magazine base or pistol grip cap: In order to make your choice easier or challenge your creativity, you will find a selection of “standard suggestions” from the ATELIER 1751 on the following pages.



AVANTGARDE GRANDE LUXE
OAK LEAVES

HAND-ENGRAVED – BECAUSE IT IS A SAUER

English scroll with roe deer, vine leaves with wild boar or fallow deer with oak leaves: Compose your engraved firearm according to your personal preferences and wishes. We turn your passion into eternal works of art.

AVANTGARDE GRANDE LUXE ENGLISH SCROLL



AVANTGARDE GRANDE LUXE
VINE LEAVES



GEMS MADE OF WOOD

Nothing makes your hunting rifle as unique as a noble wooden stock. Each one is one-of-a-kind, a masterpiece of nature, grown and matured for decades or even centuries, a play of light and shadow, colours and patterns. At Sauer, you can now choose your own distinctive stock wood within the grades 6 to 10. Give your firearm its very own character!

Select the stock wood of your dreams
now online in the Sauer stock
wood portal!





WOOD GRADE

5

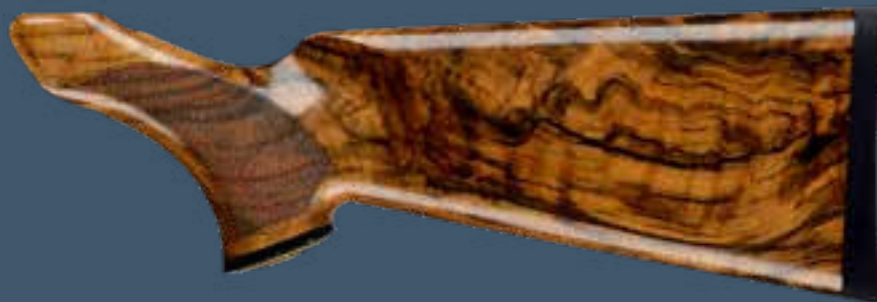

WOOD GRADE

6

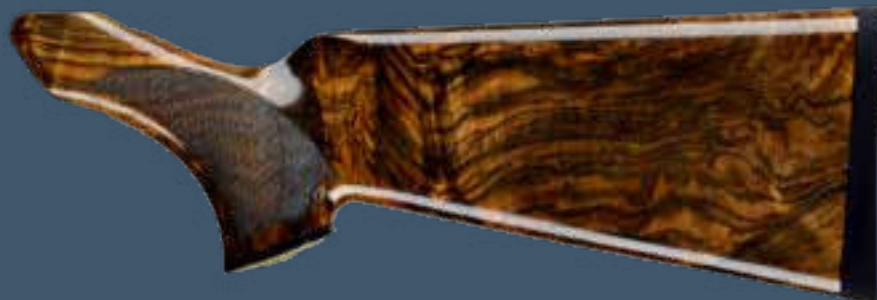

WOOD GRADE

7



Only the wood of the walnut is sufficiently fine-pored and at the same time has short and firm fibres. It “stands”, as the expert says, and this later characterises the robustness of the stock. Despite its hardness, walnut wood can be worked very well.

The really good pieces, from which the hands of experienced craftsmen create real masterpieces mainly come from Turkey or the Caucasus region. In these regions the walnut is still a staple food and whole families live from the trade in walnut wood.

The harvest is however very modest. In order to filter out one or two top-class pieces and a dozen luxury category woods, a good 100 cubic meters of walnut are required. The reason: the most beautiful wood is hidden in the heart and root area. Cracks, inclusions and branches are however also concentrated in these areas. In other words: not every batch of the raw material supplied is usable for gun stocks.

At J.P. SAUER & SOHN you have the option of choosing between 10 wood stock grades.

Striking marbling makes the stock rise in class. Likewise longitudinal stripes or isolated black veins as a contrast to the ground colour. In the highest grades, there are samples with particularly intensive markings, wild grains all over, and those with rings, clouds and bird's eyes on both sides. It is the balanced distribution that makes the noblest wooden stocks exquisite rarities.

On these pages, this becomes visible from grade 5 onwards: the light, but nevertheless striking grain

becomes more contrasting and more pronounced with each further wood grade. With a honey-coloured basic tone, as wood grade 5 or 8, the dark veins stand out very clearly. Marbling - seen here very nicely on class 9 - increase with increasing wood grade.

Bird's eyes form the top of the quality grade, provided they are distributed over the entire stock wood. They are the result of intergrowths in the tree, they are evidence of a very narrow ring structure and are correspondingly rare.

WOOD GRADE

8



WOOD GRADE

9



WOOD GRADE

10





SAUER 404
THE NOBLE DIFFERENCE

With the bolt action rifle S 404, J.P. SAUER & SOHN proudly presents the refined distillation of concentrated practical knowledge and 21st century technology that has been built upon the foundation of more than 270 years J.P. SAUER & SOHN history.

The flagship of our product range epitomises no more and no less than the essence of our historically successful bolt action rifles. Like no other, the S 404 corresponds to the highest demands in terms of safety, precision and flexibility – today and in the future. It yet remains, what you neither can deny nor conjure up, only see, feel and sense: a timelessly beautiful bolt action rifle that has grown over generations and that is made for the generations to come.

This is perfection in its most elemental form or briefly:
a real Sauer.



SAUER 404 THE NOBLE DIFFERENCE



INGENIOUSLY SIMPLE – SIMPLY INGENIOUS

The Sauer SUS universal key appears at first glance to be no more than a detachable fore-end sling swivel. Upon removal it is revealed to be a super stable German-made folding allen key that is essentially responsible for the individualisation of your S 404. As an onboard tool that is attached to the rifle sling, it can neither be forgotten nor get lost – thus providing utmost flexibility at all times.



16 CALIBRES – ONE PROMISE

By introducing the S 200 in 1985, J.P. SAUER & SOHN has laid the foundation for the nimbus of unsurpassed precision. The key technology: Three clamping bolts in the receiver hold the barrel tension-free and six massive bolt lugs positioned directly behind the chamber lock the bolt. For more than 30 years now, this has been the formula for the easy interchange of barrels and calibres while providing match grade precision at the same time. A promise that will persist in the S 404 – for generations.

ADJUST, KNOW, SHOOT

An adjustable trigger featuring four different trigger pull weights that are individually adjustable is the perfect answer to the physiological effect chain of knowledge and acting. Would you ever go without the magnification scale on your variable rifle scope? Crisp 550, 750, 1,000 or 1,250 g (1.2, 1.6, 2.2 or 2.7 lb) leave no doubts that you are programmed for success already prior to taking your shot.



IT IS YOUR GUN AFTER ALL

Every successful competition shooter knows: Only the optimum position of the shooting finger on the trigger blade provides proper trigger pull and controlled shooting without the risk of missing the target. With an 8 mm (0.3") adjustment range for length of pull and a left-to-right swivel range of 5 degrees, the S 404's extra-wide trigger blade guarantees each shooter optimal contact to reliably hit the target.



SAUER 404 THE NOBLE DIFFERENCE



MANUAL COCKING SYSTEM WITH SAVVY

The ergonomically perfect metal cocking slide on the bolt shroud allows the rifle to be cocked both comfortably and extremely silent. By pressing the button with the thumb, the cocking slide silently slides back into the uncocked position. In addition it is also possible to load and unload the rifle in the uncocked position: To do so, simply slide the cocking slide 2 mm forward and safely open the bolt.



PLAY IT SAFE AND GO MODULAR

Meeting your friends after hunting – do I leave the rifle in the car? Risks ahead? Not with the S404. In just two simple steps the bolt head can be separated from the bolt body and conveniently disappears in your pocket. Firing the rifle therefore is totally impossible. Changing the bolt head for different calibres is just as safe and easy. This means: safety and modularity are combined the smart way.

PERFECT ALLIANCE

The S 404's specially designed Sauer Universal Mount (SUM) combines an extremely low and elegant profile with absolute shooting stability and return to zero. This ensures that the shooter can focus on the target at lightning-fast speed and does not need to lift his head in order to use the full potential of accuracy. The SUM is available for all common mounting rails as well as for all ring diameters from 1 inch to 40 mm.



SIMPLY PERFECT

The perfect magazine lock must effectively prevent the unintentional unlocking of the magazine in any situation. The perfect magazine lock must be positioned where the magazine is operated – directly on the magazine button. The perfect magazine lock must be unlocked at lightning speed so that a full magazine is instantly available when the situation becomes critical. The perfect magazine lock is called the Sauer MagLock.



S 404 ELEGANCE

Confidently stylish, serene and masterful. The superior concept of the S 404 paired with a deluxe grade 5 walnut stock offers a timelessly beautiful bolt action rifle of technical and artistic perfection to the true aficionado.



The carbon sandwich construction in the fore-end avoids twisting and warping of the wood in wet conditions and/or during temperature changes. This ensures constant precision over generations without any compromise of design.



S 404 STUTZEN SELECT

No other bolt action rifle epitomises traditional hunting as tasteful as a Stutzen. Yet no other bolt action rifle holds similar challenges when it comes to constant precision in all climate zones and over decades. What until recently has been close to the impossible, Sauer & Sohn has solved by integrating a one-of-a-kind Carbon Spine technology – an ultra accurate and under all conditions ultra reliable hunting rifle in the classic design of a full-stock beauty.

S 404 SILENCE TI*

Silencer and rifle as a unit – optically attractive and optimally balanced: The new S 404 Silence TI with integral silencer boasting a barrel and silencer jacket made of titanium. It is “the” rifle for hunters who would like to be in the field without hearing protection, but at the same time do not want to compromise in protecting themselves and their dog’s hearing while shooting.





The continuously variable integral silencer combination distributes the weight of the silencer over the entire length, thus providing less top-heaviness than an over- or an on-barrel silencer. This type of construction design promises the hunter not only absolute control, but also a better swing performance – especially when shooting at moving targets.

*Not available in USA.

S 404 CLASSIC

The classic wood and metal design leaves no room for doubt that the owner of an S 404 Classic believes in the values of traditional gunmaking.





S 404 ARTEMIS

Already when mounting the S 404 Artemis for the first time, this premium rifle for huntresses gives you the absolute confidence of shooting instinctively and hitting safely. It boasts a shorter stock that is optimised around the pistol grip to perfectly provide both control of the rifle and optimal trigger contact.

The infinitely adjustable comb brings the thumbhole stock to perfection. This concept is a major part in comprising all elements that are paramount to taking aim confidently and pulling the trigger perfectly.

Manual cocking system, ergonomically positioned on the bolt shroud.

Mounting base integrated in the receiver for an extremely low profile and utmost precision.



Single-stack detachable magazine for three or five shots in Medium calibre.

The carbon stock provides minimum overall weight and reduced recoil.

S 404 SYNCHRO XTC

The S 404 Synchro XTC perfectly shows how timeless gun making with cutting-edge materials is done. The handcrafted stock made of meticulously laid carbon fibres gives the Synchro XTC its extremely low overall weight of only 2.7 kg (5.9 lb) and provides, in combination with the fluted barrel, optimum balance. At the same time the shock-absorbing carbon considerably reduces the recoil.

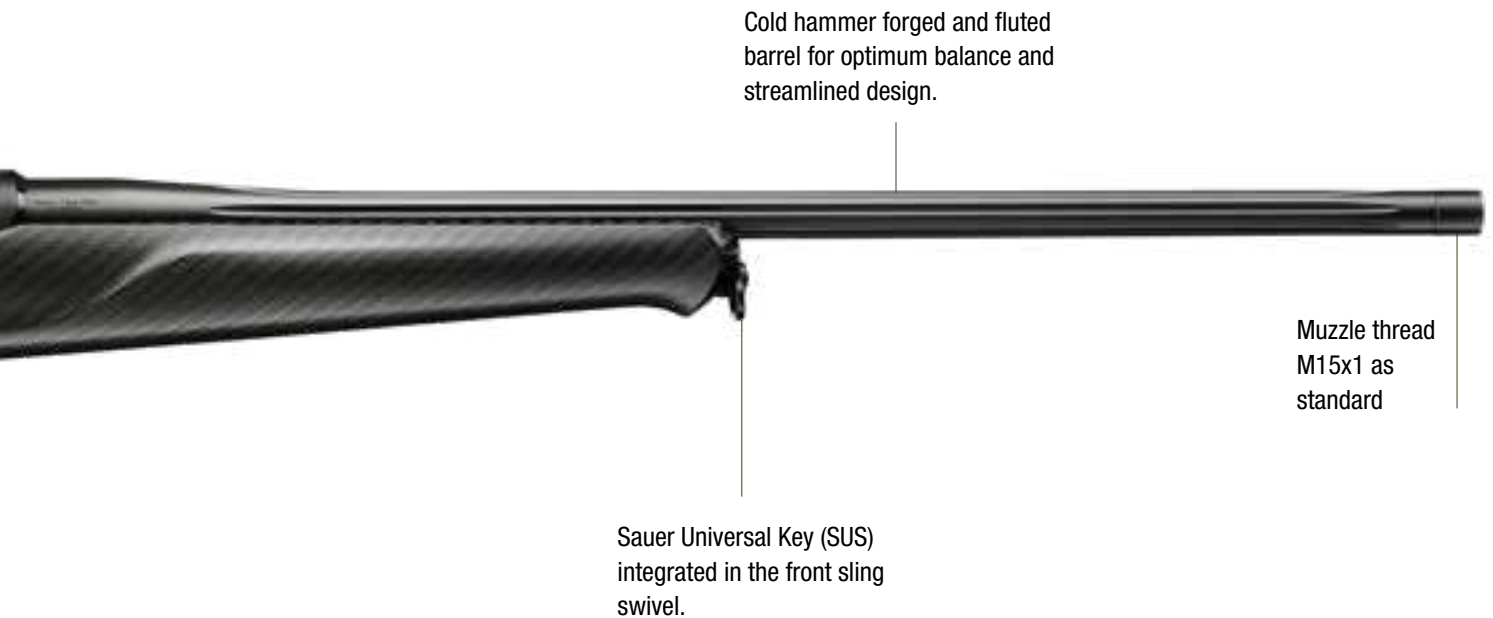



SAUER 404 SILENCE XTC*

Noble. Lightweight. Silent. These are the assets that perfectly describe the new S404 Silence XTC.

It is the perfect unity of timeless gun design and innovative engineering with the latest suppression technology. Its integral silencer boasting a barrel and silencer jacket made of titanium protects the hearing of hunter and dog. In combination with the ergonomic thumbhole stock made of hand-laid carbon, this not only guarantees optimum balance and pleasantly lightweight handling, but also minimises recoil.



NEW



S 404 CLASSIC XT

The uncompromising all-rounder for all requirements and every hunting situation. Modular, ergonomic, precise and functional like any other S 404, the Classic XT convinces with its absolutely robust and aesthetic polymer stock.





S 404 SYNCHRO XT

All the advantages of the Classic XT are complemented by a thumbhole stock with adjustable comb to form the S 404 Synchro XT. This rifle not only promises its owner a maximum in ergonomics, stability and shooting comfort but also keeps this promise in any situation.



SAUER 101
TRADITIONAL COMMITMENT

The S 101 is the premium rifle for hunters who prefer a classic firearm without a modular system but do not want to forego the legendary Sauer characteristics like precision, smooth bolt operation, reliability and perfect balance.

Completely designed in traditional style, the S 101 is nevertheless packed with unique details inspired by the Sauer premium class. A rifle was born which will still inspire our granddaughters and grandsons.



The height-adjustable comb aligns the shooter's eye optimally and ergonomically perfect behind the rifle scope

The SAFE OPENER allows for opening the rifle in the safe position at the push of a button

The direct firing pin safety operates as an ergonomic slide on the bolt shroud

Detachable magazine made of composite material for 5 Standard or 4 Magnum cartridges

Extra wide single-stage trigger with 950 g (2 lb) trigger weight

The S 101 GTI's thumbhole stock provides taking aim ergonomically and absolutely relaxed

S 101 GTI

The S 101 GTI is at the top of its class when it comes to ergonomics. The crucial detail for relaxed and accurate shooting is its height-adjustable comb. This means ideal alignment of the eye and the rifle scope, relaxed posture of the hand and optimal trigger pull. In addition the S 101 GTI comes with further top features like a barrel with muzzle thread, detachable sling swivels as well as a bipod adapter.

Barrel and receiver are connected completely tension-free thanks to the special HEAT-LOCK procedure. This results in Sauer precision at the top level

Cold hammer forged original Sauer barrel for maximum shooting performance

Sling swivel detachable at the push of a button

Muzzle thread M15x1 as standard

Bipod adapter (Harris and similar)

The patented EVER REST concept turns the symbiosis of ultra robust bedding and maximum decoupling of barrel and receiver into reality – which has been considered impossible up to now. This provides precision both even under the most extreme climatic conditions and after several thousand rounds

SAUER 101 SILENCE GTI*

Our rifles have impressed generations of hunters across the world for almost three centuries, and now the new Sauer 101 Silence GTI will contribute to this success. This rifle astonishes hunters with its spectacular features such as its laminated wood ergonomic thumbhole stock, its height-adjustable comb, and the integral silencer with a barrel and silencer jacket made of titanium. The Sauer 101 Silence GTI has a timeless elegance and reliable precision, combined with its perfect balance and its ergonomics for an impeccable shooting position. This is the perfect bolt action rifle for a new generation!





NEW

S101 ARTEMIS

The optimum stock dimensions for ladies are the heart of the S101 Artemis. Compact stock length, a sleek pistol grip and a reduced distance between trigger and shooting hand form the three pillars on which the perfect fit for huntresses rests. Not only the stock but the whole setup is designed to impress. Thanks to the 51 cm barrel the Artemis captivates with its outstanding balance at an overall weight below three kilograms.





*Picture shows optional extra: adjustable comb.



*





NEW

SAUER 101 ARTEMIS ELEGANCE

The most elegant from the Artemis line. This premium bolt action rifle for women offers all features of the S101 Artemis, like low weight, compact length, slender pistol grip and a reduced distance of shooting hand and trigger. In addition, it boasts a fine grade 4 walnut stock, a black aluminium bolt knob as well as a red recoil pad. The perfect rifle for every huntress who values style and elegance just as much as innovative firearm technology.



S101 CLASSIC

As the name already suggests, the S101 Classic is the classic entry-level model into the S101 family. Due to the slim lines of its full stock made of walnut burl and its elegant Schnabel fore-end, the S101 Classic reflects the tradition of timelessly beautiful hunting rifles from J.P. SAUER & SOHN.





S101 SELECT

Featuring a modern laser grain on the walnut stock and a traditional jewelled bolt body, the S101 Select is the perfect example for the elegant bond of solid gunmaking and revolutionary wood processing.

* Picture shows optional extra: adjustable comb and red recoil pad.



SAUER 101 ELEGANCE

A classy bolt action rifle for those hunters who set distinctive demands to themselves, the technology of their equipment and the aesthetics of their firearm – and this rifle is also the male counterpart to the S 101 Artemis Elegance!

The S 101 Elegance combines all features of the S 101 series and impresses above all visually with its fine grade 4 walnut stock, the red recoil pad, the jewelled bolt as well as the black aluminium bolt knob. This elegant bolt action rifle is optionally also available with a height-adjustable comb.



*

S101 HIGHLAND XTC

Sauer's new, perfectly balanced all-round rifle. Equipped with a hand laid real carbon fiber stock, fluted barrel including muzzle thread, fluted bolt and all top-features of the S101 line. Everything with a total record weight from 2.455 grams (5.4 lbs).





S101 CLASSIC XT

When you can no longer improve on technology, all that remains is to protect it even better. The rugged polymer stock of the S 101 Classic XT defies all adversities and provides a secure and silent handling thanks to its Soft Touch Coating.





NEW

SAUER 101 HIGHLAND XTA

It is the most robust and resistant rifle of the S 101 series. The S 101 Highland XTA braves wind, weather and adverse conditions with its non-slip polymer stock with Soft Touch and its special DLC coating. Despite technical innovations it is totally in tune with the classic Sauer look and boasts the ergonomics that are distinctive for the Sauer series 101. Lightweight, straightforward, precise: This is the new Sauer 101 Highland XTA – there can only be one!





SAUER 100
THE BEST OF ITS CLASS

Besides reliability and best craftsmanship, the S 100 combines all necessary characteristics of a contemporary hunting rifle from J.P. SAUER & SOHN. Everything is just right: performance, quality, price.

With the S 100, J.P. SAUER & SOHN has raised the standard for entry-level bolt action rifles to a whole new level. Its compelling features like the adjustable single-stage trigger, a three-position safety, the cold hammer forged barrel, Sauer's famous smooth bolt motion and the elegant and ergonomic stock geometry inspired by the successful S 404 and S 101 bolt action rifles make the S 100 the measure of all things in its class.



S100 FIELDSHOOT

Target shooting or varmint hunting: The new S100 Fieldshoot is the perfect choice when maximum focus on the target is paramount. From the outside the rifle captivates through a laminate wood stock with a dark oil finish that can be adjusted individually to the shooter's needs. In addition, the 620 mm (24") long Varmint Match barrel with 22 mm (0.86") taper makes the Fieldshoot a precision-guarantee for long-range shooting and long shooting series.



Steel body
surface: blued

Adjustable
comb

Cone shaped alloy bolt handle

Recoil pad adjustable
sideways and in height

Adjustable
trigger weight
1,000 – 2,000 g
(2.2 – 4.4 lb)

Specially designed stock for shooting
in perfect prone position while using
a bipod



Barrel: Varmint Match barrel with
620 mm barrel length (24 ")
Muzzle diameter: 22 mm (0.86 ")
Surface: blued

Muzzle thread
M17x1

Ventilated fore-end for
optimal heat dissipation





NEW

SAUER 100 ARTEMIS

The purist from the Artemis line – especially developed for women. Although being reduced to the essentials, this rifle has everything a modern hunting rifle needs and is ergonomically optimised for women: an ERGO COMPACT stock for the perfect position of the head when looking through the scope, a slender pistol grip as well as a reduced distance between pistol grip and trigger blade. The height-adjustable comb provides fast target acquisition, as the sighting line instantly fits when aiming intuitively. The three-position-safety combines easy handling with maximum reliability. The cold-hammer forged barrel ensures guaranteed accuracy, while the walnut stock tastefully rounds off the rifle's appearance. Simply a true women's weapon!



S100 CLASSIC XT

Quality made in Germany, precision made by Sauer: Featuring a handy and robust polymer stock, the S 100 Classic XT offers unrivalled value for money.





S100 CLASSIC

The model Classic is the tasteful entry into the world of the S 100. The rustic walnut stock and the matt burnished barrel surface give this rifle the appearance of a traditional tool.

S100 STAINLESS XTA

The brand new S 100 Stainless XTA combines outdoor durability, shooting ergonomics and elegance in one rifle.



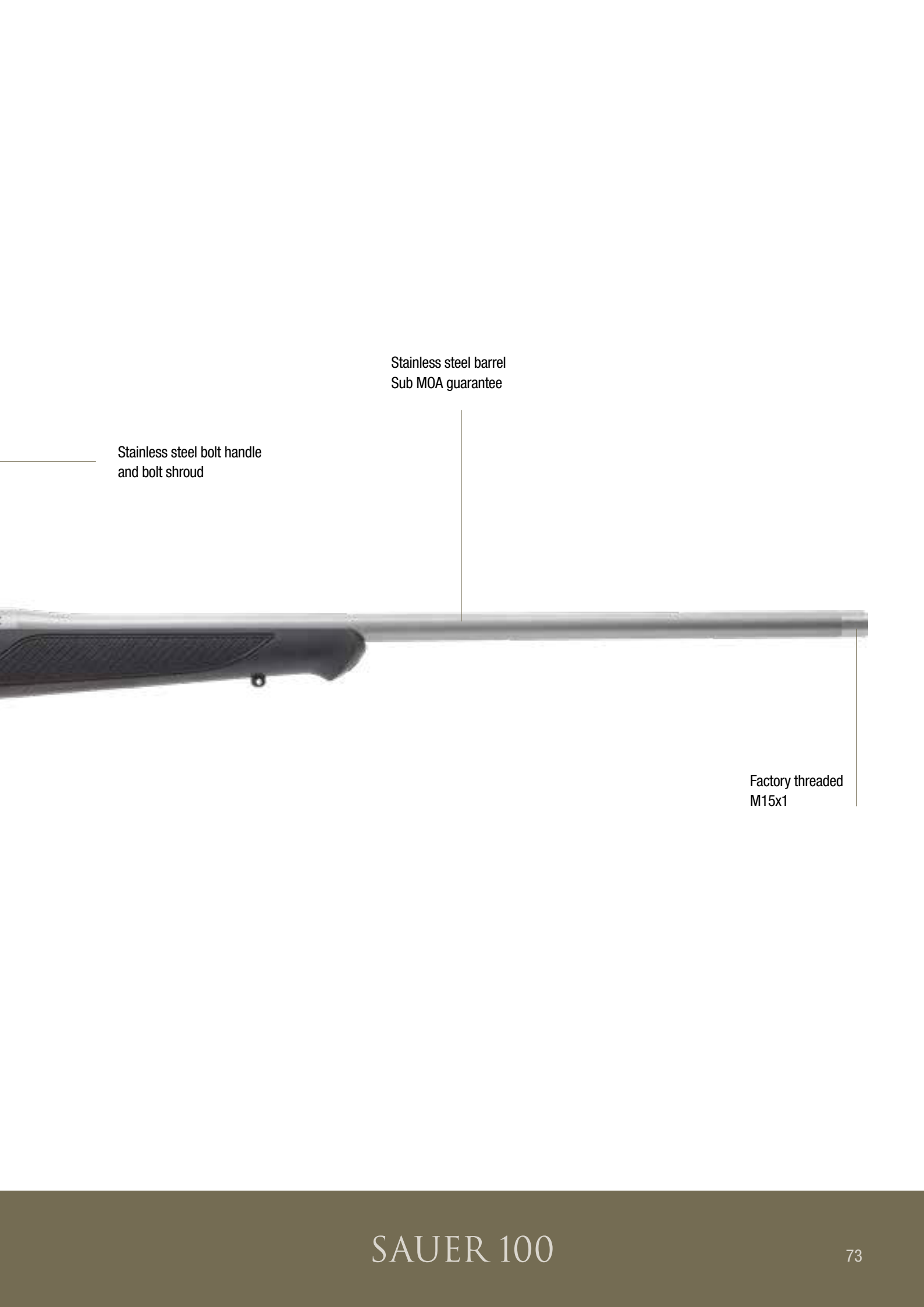

Stainless steel bolt handle
and bolt shroud

Stainless steel barrel
Sub MOA guarantee

Factory threaded
M15x1



THE SAUER 303
FINE. FAST. FIRST.

When beaters are shouting and dogs are barking while shortly after boars are rushing out from underneath the thicket, it is time for the semi-automatic rifle S 303.

Our S 303 combines a classy appearance with utmost efficiency and like a double rifle, provides the safe follow-up shot without manual reloading. Yet, this rifle has even more to offer: The semi-automatic mechanism reduces recoil and muzzle rise by almost 30 percent while the precision remains unerring at all times. This makes the S 303 the unchallenged queen of hunting.



SAUER 303



IN A FLASH

Integrated in the buttstock of your rifle, the Mini Universal Key (MUS) appears at first glance to be no more than a detachable sling swivel. Upon removal, it is revealed to be a super stable allen key with which the fore-end and buttstock can be dismantled in a flash without using any other tool. This is not only brilliant while traveling, but also when the rifle gets dirty on a driven hunt and quickly has to be cleaned.



OPTIMISED DESIGN ON THE INSIDE AND OUTSIDE

The S303's completely redesigned system turns the new semi-automatic rifle into a reliable and controllable hunting companion.

PROTECTED AGAINST DIRT

The hard chrome-plated bore provides a durable protection against corrosion. This enhances the lifetime of your S 303, given that the rifle is cleaned regularly within the necessary intervals.



BLACK MAGIC TRIGGER

Adequate trigger pull for driven hunts, breaks like glass with accurate long-range shots: Breathtaking 950 g trigger pull weight make the S 303 a perfect companion for any hunting situation.



SAUER 303



EASILY COCKED

As with the S 404, the S 303's ergonomically perfect and smooth metal cocking slide on the bolt shroud also allows the rifle to be cocked both comfortably and extremely silent. By pressing the button with the thumb, the cocking slide silently slides back into the uncocked position. In addition it is also possible to load and unload the rifle in the uncocked position: To do so, simply tap the cocking slide and safely open the S 303.



EXCELLENT RELIABILITY

Its optimised gas operation ensures the S 303's excellent reliability and long service life. Its steel construction additionally provides the rifle's desired top-heaviness and thus ensures optimum swing characteristics when shooting at moving game.

ONE FOR ALL

From now on, the S 404's proven and return to zero Sauer Universal Mount (SUM) also is the measure of all things on the new S 303. This ensures that the shooter can focus on the target at lightning-fast speed and does not need to lift his head in order to use the full potential of accuracy. The SUM is available for all common mounting rails as well as for all ring diameters from 1 inch to 40 mm.



PERFECTLY SAFE

The proven and popular magazine lock MagLock now also secures the magazine of the S 303. Thanks to its optimum position, it does not only prevent unintentional magazine loss, but literally is unlocked at one single stroke when a new magazine must be available rapidly.



S 303 SELECT

Ergonomics in classic design: The new S 303 now also comes with a wooden stock boasting an elegant and striking laser line grain. The basic version of the new Sauer semi-automatic rifle is the most elegant entry into the world of efficient hunting.





S 303 ARTEMIS

The first semi-automatic rifle that is completely tailored to female hunters does not compromise: shorter buttstock, modified cast and a slim pistol grip. For the efficient hunting of hoofed game.

S303 CLASSIC XT

Thanks to its ultra-rugged synthetic stock, the S303 Classic XT is the all round semi-automatic rifle for ambitious hunters – for every kind of hunting and in any weather.





S 303 SYNCHRO XT

With its robust and ergonomically sophisticated thumbhole stock and adjustable comb, the S303 Synchro XT impressively proves that an elegant hunting rifle does not necessarily need a wooden stock.



J.P. SAUER & SOHN

ESTABLISHED 1751

SAUER SHOTGUNS
MILESTONES OF FINE HUNTING

**Since 1751, J.P. SAUER & SOHN
has inspired generations of hunters with true
milestones in the history of shotguns.**

Be it the legendary Meisterwerk Shotgun at the end of the 19th century, the first almost completely machine-made double-barrel hammer shotgun “Reiher” in 1925, the first Sauer over and under shotgun of 1933 or the successful and popular cooperation products with other gun manufacturers between the 1960s and 1990s.

Until today, all these models are a synonym for hunting shotguns of superior design. Following this tradition Sauer & Sohn still presents shotguns that fascinate huntresses and hunters equally through uncompromising performance, unrivalled balance and timeless beauty.





The Ergofit inlays allow to individually adjust drop and cast to both right- and left-handed shooters.



SEMI-AUTOMATIC SHOTGUN SL5

The moment a flock of ducks is crossing the sky in optimum shooting distance, all shotguns are mounted. Rapid shots make a trio of bright-feathered drakes fall from heaven. With the semi-auto shotgun SL5, triples are not left to chance. Sauer's youngest shotgun scion combines the power of a semi-automatic with the balance and "shootability" of a classic hunting shotgun. Finally its elegant design perfectly rounds off this "triad".



The sling swivels can easily be removed at the push of a button and allow that the rifle sling is stowed where it belongs: in the case.



The core of the SL 5:
the legendary Inertia breech



Matt nickel
plated bolt head

Hard anodized
body

The laserline grain on the
walnut stock appears classy
and looks like natural cam-
ouflage



Ergonomically perfect,
extended pistol grip

Lateral safety button
in the trigger guard



Trigger and all system
parts made of metal

SEMI-AUTOMATIC SHOTGUN SL5 INSTINCTIVE SPEED, TIMELESS ELEGANCE

The proven semi-automatic shotgun by J.P. SAUER & SOHN is the best proof that a semi auto can be an eye-catcher. Just like the outer qualities, also the inner values are captivating: From recoil pad to muzzle all technical top features that make up a top-class shotgun are combined.

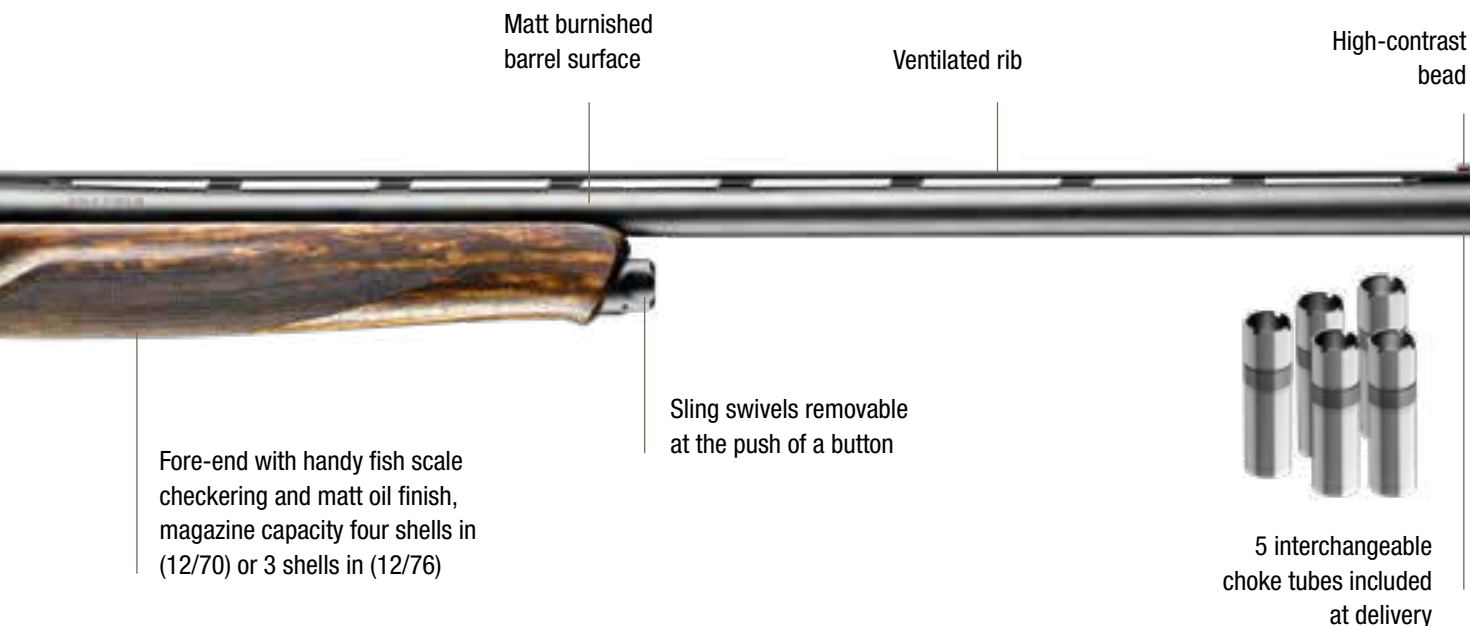



SAUER ACCESSORIES

**Your Sauer is more than just a firearm.
It is a statement of the way and manner you hunt.**

The original accessory range of J.P. SAUER & SOHN underlines the elegance and reliability of your Sauer. Premium products that do not only represent the character of your rifle or shotgun but above all their own. Of course in the well-known quality of Sauer & Sohn.



SAUER LEATHER ACCESSORIES

1 |



1 | SAUER WEEKENDER

The perfect companion for your weekend trip – not only for hunting.

2 | SAUER CARTRIDGE CASE

The cartridge case is not only extremely elegant, but also very well thought out and designed: In addition to the elastic loops for ammunition, the case features a second row of so-called projectile loops that protect the bullet tips from damage.

2 |



3 |



3 | SAUER BOLT HOLSTER

Useful accessory to safely protect the bolt: the new Sauer bolt holster. Thanks to the practical holster, you can carry the bolt chamber of your Sauer rifle comfortably on your belt.

4 | SAUER RIFLE SLING

Rifle sling made of fine nubuck leather. These slings complete the noble appearance of rifles with high-quality wooden stocks. Available in braided and classic version.





4 |



5 |



6 |

5 | SAUER LEATHER BELT

Whether it is for hunting or business: The Sauer leather belt made of soft calf nubuck leather stylishly complements your hunting look.

6 | SAUER HUNTING LICENSE CARRIER

The practical and classy storage for important documents such as hunting license, gun permit and firearms pass.

SAUER ACCESSORIES



1 | SAUER HUNTING BELT – THE ALTERNATIVE TO A BACKPACK

Who hasn't experienced it: There's not enough room in your pants and jacket pockets for everything you need for a raised hide, stalk or driven hunt, but a backpack is not an alternative because it takes up too much space on a narrow raised hide. The new Sauer hunting belt provides the perfect solution. Adjustable in length up to 130 cm, three spacious, waterproof pockets offer enough space for everything that should not be missing on the hunt, from thermal imaging device to snacks.

2 | SAUER CAP BROWN

The high-quality classic Sauer cap has a water-resistant membrane perfectly suited for all types of active hunting in bad weather conditions. The brown plain cap is the perfect fit for hunting and daily use. It includes a side loop for fixing a branch.

3 | SAUER BACKPACK

Light, flexible, elegant: The new Sauer hunting backpack not only looks great but is also perfectly designed down to the smallest detail. Made of extremely water-repellent and low-noise membrane material with waterproof seams.



4 |



5 |



6 |

4 | SAUER HUNTING BAG

Lightweight and silent: The Sauer hunting bag accommodates everything you need when sitting game in a raised hide. The bag can easily be hung over the window breast in the raised hide so that all pockets are quickly and easily within reach. Also perfectly suitable as a rifle rest.

5 | SAUER SHOOTING PILLOW

Small, light, quiet: The Sauer shooting pillow is a convenient shooting pad that no hunter should be missing. With push & go sling swivels, the shooting pillow can be attached to a backpack for transport or for mounting on the fore-end of the S 404.

6 | SAUER STALKING SLIP

Made out of quiet polyester, the stalking slip offers great protection from splashing water and scratches. It can be removed within seconds if the rifle quickly has to be brought to the 'ready' position. For transport in the hunting backpack, the stalking slip can be stowed in the integrated pocket.

SAUER ACCESSORIES

1 |



1 | SAUER REVERSIBLE HAT

Stylish reversible cap with Sauer logo made of high-quality knit, one side in a strong signal colour, the other in hunting green. The ideal companion for battue and driven hunts as well as for the cold season!

2 | SAUER CAMO CAP GREEN

The high-quality Camo Cap has a water-resistant membrane. Perfectly suited for all types of active hunting in bad weather conditions. The size is flexibly adjustable.

2 |



3 |



3 | SAUER MULTIFUNCTION SCARF

Original Sauer multifunction scarf for the active hunter made of elastic material. The high-quality fabric warms you in winter and cools your skin in summer!

4 | SAUER CAMO CAP REED

High-quality camo cap for feathered game hunting. The cap is equipped with a waterproof membrane, which makes it ideal for adverse weather. Including a side loop for fixing a branch. The size is flexibly adjustable.

4 |



6 |



5 |



7 |



8 |



5 | SAUER CAMO CAP ORANGE

The high-quality Camo Cap for driven hunts has a water-resistant membrane. Featuring a signal orange camo pattern which is highly apparent for humans, but not for game. This means maximum safety and maximum success for the hunter.

6 | SAUER CAMO CAP

The high-quality Camo Cap for all types of active hunting – the all-season companion for sitting game, stalking or lure hunting. Water-resistant membrane and a side loop for fixing a branch. The size is flexibly adjustable.

7 | SAUER DRIVEN HUNTING CAP

Classic signal cap in bright orange. Black peak underside for perfect protection of the targeting eye. Waterproof, flexibly adjustable size and side loop for fixing a branch.

8 | SAUER CAMO CAP SNOW

The high-quality Camo Cap for hunting in wintertime with a water-resistant membrane. Including a side loop for fixing a branch. The size is flexibly adjustable.

SAUER ACCESSORIES



1 | SAUER RIFLE CASE CANVAS

Robust Canvas case for your Sauer rifle with separate pocket for further equipment. Available in two sizes. (short: 45", long: 51")

2 | SAUER ABS COMPACT CASE I

Its thought out modularity makes the S 404 the perfect travelling companion. Especially for this purpose we have designed a perfect and inconspicuous transport case with extremely handy dimensions of only 84 x 18 x 14 cm (33.1 x 7.1 x 5.5").



2 |



3 |



4 |



3 | SAUER ABS COMPACT CASE II

You cannot transport two firearms more comfortable or discreet than with the ABS Compact Case II. Featuring outer dimensions of 84x24x14 cm (33.1x9.4x5.5"), the Compact Case II provides ample space for one firearm including interchangeable barrel and second rifle scope as well as the Titanium Pro silencer and the Flexpro bipod.

4 | SAUER CARBON COMPACT CASE

The carbon case is a true high tech statement when it comes to technology and design. It is not only a must-have for the owner of a S404 Synchro XTC, but also for those enjoying the best materials and a premium look.

SAUER ACCESSORIES

1 |



1 | SAUER UTILITY BELT

Strong, sturdy and reliable: With its tensile load of 400 kg, the Sauer utility belt masters every situation and is an absolute "must have" for every hunter. For recovering heavy game, several utility belts also can be combined.

2 | SAUER FOLDING GAME CARRIER

Extremely tear-resistant and foldable game carrier in J.P. SAUER & SOHN design. The carrier is not only space-saving to store, but due to its welded seams 100% waterproof, furthermore easy to clean. Capacity of 140 litres.

2 |



3 | SAUER REST RIFLE SLING

Maximum comfort: Anti-slip, wide shoulder pad as well as soft, double-lined fore-end rest. Available in brown, green, black and orange.

4 | SAUER SILENCER COVER

The Sauer silencer cover prevents unwanted noise during the hunt and allows longer series of shots without mirage.



3 |



4 |



5 |



7 |

5 | SAUER CARBON BIPOD

Especially designed for long-range shots with the S 404. It can rapidly be attached via the front sling swivel bushing to provide absolute stability and utmost shooting comfort.

7 | SAUER – THE HUNTING GAME

This hunting game should not be missing in any hunter's household or hunting lodge! Many hunters still remember the game from their own childhood, when they would up and go on exciting hunts with their friends, siblings or parents. Sauer revives the 1950s classic in its original version.

6 | SAUER CARBON RIFLE SLING

Fitted with comfortable, non-slip neoprene material on the inside and with a stylish carbon look on the outside, the Sauer carbon rifle sling combines style, comfort and robustness. Adjustable in length.

SAUER ACCESSORIES

1 |



4 |



2 |

3 |

Recoil pad
Standard



Speed Cap

Recoil pad
35 mm

5 |



1 | SAUER MUZZLE THREAD AND MUZZLE BRAKE

A muzzle thread is optionally available for all Sauer rifles with factory muzzle threading. Combined with the removable DUAL BRAKE muzzle brake the recoil is decreased while increasing shooting comfort and accuracy.

2 | SAUER SILENCER TITANIUM PRO*

Besides its outstanding technical characteristics, the Sauer silencer Titanium Pro stands out through its low weight, slim and streamlined shape and convenient disassembly for easy cleaning and care.

3 | SAUER RECOIL PAD

With all Sauer synthetic stocks you can choose between three recoil pads which of course can be retrofitted and make the rifle fit your individual body size. Above all the Speed Cap allows for fast mounting and a better shooting position with thick winter clothes.

4 | SAUER SCOPE MOUNT HEXALOCK

The Sauer HexaLock is the ideal mount for the S100 and S101. A low profile, 100 % return to zero and simple, comfortable operation. For use with clip-on devices, the HexaLock mount is also available in an elevated design.

*Not available in USA.

6 |



5 | SAUER SUM MOUNT (SUM)

The Sauer Universal Mount (SUM) now does not only fit the S 404, but also the S 303. This means: One and the same rifle scope as well as one and the same mount can be used for both the S 404 and the S 303.

6 | SAUER CARE & CLEANING KIT

Only the best for your S 303: Thanks to this cleaning kit you can give your S 303 the care it needs after tough use.

7 |



8 |



7 | SAUER GUN CARE KIT

With this gun care kit that consists of degreasing agent, gun oil and microfibre cloth, you can reliably protect your Sauer rifle against corrosion.

8 | SAUER BORE BLITZ

The cleaning cord "to go". Just pull it through two to three times through the barrel and it will shine like new.



1 |

1 | SAUER SOFTSHELL JACKET

Softshell jacket in classic style with chest pocket and Sauer logo. The windproof softshell fabric and the warming fleece lining make this jacket a comfortable and weatherproof favourite. Colour: chocolate.



2 |

2 | SAUER SOFTSHELL VEST

This classic softshell vest with chest pocket and Sauer logo keeps the upper body reliably protected, while the arms enjoy total freedom of motion. Windproof and warming at the same time! Colour: chocolate.



3 |

3 | SAUER SHIRT

Stylish shirt with elegant checkering for leisure, hunting and everyday life. Its button down collar, discreet colours and the Sauer branding provide a classy look. Pleasantly light and airy to wear on the skin!

SAUER LOGO WEAR

NEW

Those who own a genuine Sauer have usually been close to the Sauer brand for generations. And will remain so. Or you may have just discovered your passion for Sauer. And want to live it. In any case, the new logo wear adds the extra bit of Sauer lifestyle to your ventures – whether in your leisure time, when hunting or in everyday life. Must-haves for true Sauer hunters!

4 |



5 |



4 | SAUER POLO SHIRT

Timeless piqué polo shirt for hunting and leisure with three buttons and Sauer logo. Thanks to the combination of cotton and polyester, the shirt is easy-care and quick-drying. Available in chocolate and sepia.

5 | SAUER T-SHIRT

Basic T-shirt in chocolate or sepia. Quick-drying and easy-care thanks to its cotton-polyester material mix. Simple, plain, practical.

CLASSY BLADES

Those hunting with a Sauer, hunt in style. With a Sauer hunting knife you can look after your game as classy as you have harvested it. As with the rifles, Sauer & Sohn also gives special attention to precise workmanship, premium quality and tasteful design when it comes to hunting knives.

1 |



3 |



ENGRAVING POSSIBLE

2 |



4 |



ENGRAVING POSSIBLE

1 | SAUER HUNTING KNIFE WALNUT

8.5 cm (3.47 inch) long drop point blade made of 440 stainless steel, with walnut grip plates and saddle leather sheath.

2 | SAUER HUNTING SKINNER WALNUT

Hunting knife with skinning hook and 7 cm (2.76 inch) long 440 stainless steel blade, with walnut grip plates and saddle leather sheath.

3 | SAUER HUNTING SKINNER MOUFLON

Grip plates made of elegant mouflon horn, 7.5 cm (2,95 inch) blade in Sandvik 60 HRC steel, brown saddle leather sheath.

4 | SAUER HUNTING KNIFE STAG

10 cm (3.94 inch) long blade made of Sandvik 60 HRC steel. Real stag horn handle, matt finished silver plates incl. robust saddle leather sheath.



shop.sauer.de/uk/Knives



5 |



6 |



7 |



8 |

5 | SAUER COOKING KNIFE

Premium cooking knife with hand-crafted blade in 56 HRC steel and grip scales made of high-grade walnut.

6 | SAUER PARING KNIFE

A true specialist for the processing of game! Drop forged in one piece from the tip to the butt, this knife is made of 56 HRC steel.

7 | SAUER SANTOKU KNIFE

The Santoku knife is a classic among the Japanese blade shapes and particularly suitable to cut meat, fish and vegetables.

8 | SAUER BREAD KNIFE

Drop forged in one piece from the tip to the butt, this knife measures 45 cm from the end of the handle to the tip. Hand-crafted blade made of 56 HRC knife steel, grip scales in walnut.

SAUER MAGAZINE-OVERVIEW

Sauer 404 Magazine

3-Round Magazine



5-Round Magazine



8-Round Magazine



Sauer 100 and Sauer 101 Magazine

5-Round Magazine



10-Round Magazine



Sauer 303 Magazine

2-Round Magazine



5-Round Magazine





5-Round Magazine
8-Round Magazine



S101
10-Round Magazine

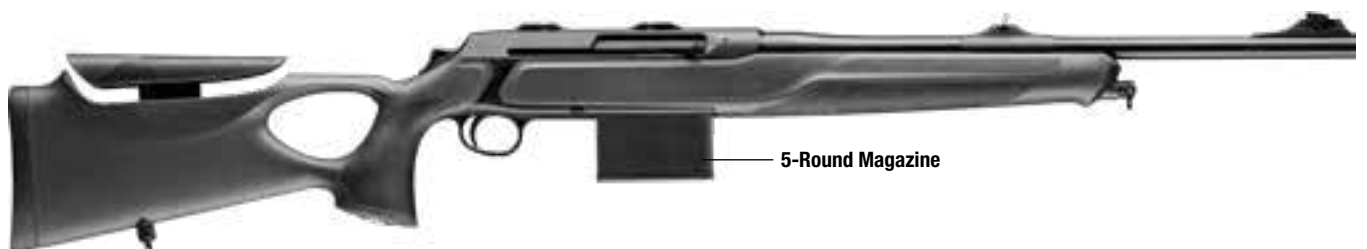

5-Round Magazine





Sauer 404 Barrels & Calibres

Calibre	Barrel length	420 mm*	470 mm*	
	Twist Rate	Contour ST	Contour ST	
Mini	.222 Rem.	305 mm / 12 inch	–	–
	.223 Rem.	305 mm / 12 inch	–	–
Medium	.243 Win.	254 mm / 10 inch	–	○
	6,5x55 SE	220 mm	–	–
	6XC	203 mm / 8 inch	–	–
	6,5 Creedmoor	220 mm	–	–
	.270 Win.	254 mm / 10 inch	–	–
	7x64	220 mm	–	–
	.308 Win.	279 mm / 11 inch	○	○
	.30-06 Spring.	279 mm / 11 inch	○	○
	8x57 IS	240 mm	○	○
	8,5x55 Blaser	305 mm / 12 inch	○	○
	9,3x62	360 mm	○	○
Magnum	7mm Rem. Mag.	241 mm / 9.5 inch	–	–
	.300 Win. Mag.	279 mm / 11 inch	–	–
	8x68 S	280 mm	–	–
	10,3x68 Mag.	450 mm	–	–
	.375 H&H	305 mm / 12 inch	–	–
Swiss	10,3x60 R	450 mm	–	–

● serial configuration // ○ optional // – not available // All information subject to change without notice.

Sauer 404 Dimensions & Weights

	Elegance	Artemis	Classic	Stutzen	Silence TI
Weight standard calibres	from 3220 g / 7.1 lbs	from 3000 g / 6.6 lbs	from 3220 g / 7.1 lbs	from 3220 g / 7.1 lbs	barrel length 420 mm / 16 inch = from 3750 g / 8.3 lbs barrel length 470 mm / 19 inch = from 3800 g / 8.4 lbs
Weight magnum calibres	from 3340 g / 7.4 lbs	from 3220 g / 7.1 lbs	from 3340 g / 7.4 lbs	–	from 3850 g / 8.5 lbs
Barrel length standard calibres	560 mm / 22 inch	510 mm / 20 inch	560 mm / 22 inch	510 mm / 20 inch	420 mm / 16 inch 470 mm / 19 inch
Barrel lengths magnum calibres	620 mm / 24 inch	620 mm / 24 inch	620 mm / 24 inch	–	520 mm / 20 inch
Overall length standard calibres	1065 mm / 42 inch	1015 mm / 40 inch	1065 mm / 42 inch	1015 mm / 40 inch	barrel length 420 mm / 16 inch = 1130 mm / 44 inch barrel length 470 mm / 19 inch = 1180 mm / 46 inch
Overall length magnum calibres	1125 mm / 44 inch	1095 mm / 43 inch	1125 mm / 44 inch	–	1.230 mm

• serial configuration // ◊ optional // – not available // All information subject to change without notice.

Silence XTC	Synchro XTC	Synchro XTC Camo	Synchro XT	Classic XT	Avantgarde Grande Luxe
barrel length 420 mm / 16 inch = from 3400 g / 7.5 lbs barrel length 470 mm / 19 inch = from 3450 g / 7.6 lbs	from 2790 g / 6.2 lbs	from 2790 g / 6.2 lbs	from 3260 g / 7.2 lbs	from 3260 g / 7.2 lbs	from 3280 g / 7.2 lbs
from 3500 g / 7.7 lbs	from 2900 g / 6.4 lbs	from 2900 g / 6.4 lbs	from 3380 g / 7.5 lbs	from 3380 g / 7.5 lbs	from 3400 g / 7.5 lbs
420 mm / 16 inch 470 mm / 19 inch	560 mm / 22 inch	560 mm / 22 inch	560 mm / 22 inch	560 mm / 22 inch	560 mm / 22 inch
520 mm / 20 inch	620 mm / 24 inch	620 mm / 24 inch	620 mm / 24 inch	620 mm / 24 inch	620 mm / 24 inch
barrel length 420 mm / 16 inch = 1130 mm / 44 inch barrel length 470 mm / 19 inch = 1180 mm / 46 inch	1065 mm / 42 inch	1065 mm / 42 inch	1065 mm / 42 inch	1065 mm / 42 inch	1065 mm / 42 inch
1230 mm	1125 mm / 44 inch	1125 mm / 44 inch	1125 mm / 44 inch	1125 mm / 44 inch	1125 mm / 44 inch

Sauer 101 Barrels & Calibres

Calibre	Barrel length	470 mm*	
	Length of twist	Contour ST	
Medium	.243 Win.	254 mm / 10 inch	–
	6,5x55 SE	220 mm / 9 inch	–
	6,5 Creedmoor	220 mm / 9 inch	–
	.270 Win.	254 mm / 10 inch	–
	7x64	220 mm / 9 inch	–
	.308 Win.	279 mm / 11 inch	○
	.30-06 Spring.	279 mm / 11 inch	–
	8x57 IS	240 mm / 9 inch	○
	8,5x55 Blaser**	305 mm / 12 inch	○
	9,3x62	360 mm / 14 inch	–
Magnum	7mm Rem. Mag.	241 mm / 9.5 inch	–
	.300 Win. Mag.	279 mm / 11 inch	–

Calibres and barrel lengths S101 Silence GTI

Calibre	Barrel length
.308 Win.	420 / 470 mm
8x57 IS	420 / 470 mm
.30-06 Spring.	470 mm
8,5x55 Blaser	420 / 470 mm

• serial configuration // ○ optional // – not available // All information subject to change without notice.

510 mm		560 mm	620 mm
Contour ST	Contour H	Contour ST	Contour ST
○	○	●	—
○	—	●	—
○	○	●	—
○	—	●	—
○	—	●	—
○	○	●	—
○	○	●	—
○	○	●	—
○	○	—	—
○	○	●	—
—	—	●	●
—	—	●	●

* Barrel length 470 mm always w/o sights and M15x1
 ** only for models Classic XT, Classic XTA, Artemis and GTI

Sauer 101 Dimensions & Weights

	Select	Artemis / Artemis Elegance	Classic	Classic XT
Weight Standard calibres	from 3050 g / 6.72 lbs	from 2900 g / 6.39 lbs	from 3050 g / 6.72 lbs	from 3050 g / 6.72 lbs
Weight Magnum calibres	from 3150 g / 6.94 lbs	–	from 3150 g / 6.94 lbs	from 3150 g / 6.94 lbs
Barrel length Standard calibres	560 mm / 22 inch	510 mm / 20 inch	560 mm / 22 inch	560 mm / 22 inch
Barrel length Magnum calibres	620 mm / 24 inch	–	620 mm / 24 inch	620 mm / 24 inch
Length overall Standard calibres	1065 mm / 42 inch	980 mm / 39 inch	1065 mm / 42 inch	1065 mm / 42 inch
Length overall Magnum calibres	1125 mm / 44 inch	–	1125 mm / 44 inch	1125 mm / 44 inch

• serial configuration // ◦ optional // – not available // All information subject to change without notice.

Elegance	Silence GTI	GTI	Highland XTC	Highland XTA
from 3050 g / 6.72 lbs	barrel length 420 mm / 16 inch = ca. 3950 g / 8.79 lbs	from 3220 g / 7.09 lbs	from 2500 g / 5.51 lbs	from 3000 g / 6.61 lbs
from 3150 g / 6.94 lbs	–	from 3320 g / 7.32 lbs	from 2600 g / 5.73 lbs	from 3100 g / 6.83 lbs
560 mm / 22 inch	420 mm / 16 inch 470 mm / 19 inch	560 mm / 22 inch	510 mm	510 mm
620 mm / 24 inch	–	620 mm / 24 inch	560 mm / 22 inch	560 mm / 22 inch
1065 mm / 42 inch	barrel length 420 mm / 16 inch = 1130 mm / 44 inch barrel length 470 mm / 19 inch = 1180 mm / 46 inch	1065 mm / 42 inch	1015 mm	1015 mm
1125 mm / 44 inch	–	1125 mm / 44 inch	1065 mm	1065 mm

Sauer 100 Barrels & Calibres

Calibre	Twist Rate
.222 Rem. **	305 mm / 12 inch
.223 Rem.	305 mm / 12 inch
.243 Win.	254 mm / 10 inch
.270 Win.	254 mm / 10 inch
6,5x55 SE	220 mm
6,5 PRC	203 mm / 8 inch
6XC *	203 mm / 8 inch
7mm-08	241 mm / 9.5 inch
6,5 Creedmoor	220 mm
.308 Win.	279 mm / 11 inch
.30-06 Spring.	279 mm / 11 inch
8x57 IS	240 mm
8,5x55 Blaser** (available Q2 2023)	305 mm / 12 inch
9,3x62	360 mm
7mm Rem. Mag.	241 mm / 9.5 inch
.270 Win. Short Mag.	254 mm / 10 inch
.300 Win. Mag.	279 mm / 11 inch

• serial configuration // ◦ optional // – not available // All information subject to change without notice.

510 mm	560 mm	620 mm		660 mm
Contour ST	Contour ST	Contour ST	Contour Match*	Contour Match*
–	•	–	–	–
–	•	–	•	–
○	•	–	•	–
○	•	–	–	–
○	•	–	•	–
–	–	•	•	–
–	–	–	–	•
–	•	–	–	–
○	•	–	•	–
○	•	–	•	–
○	•	–	–	–
○	•	–	–	–
•	–	–	–	–
○	•	–	–	–
–	–	•	–	–
–	–	•	–	–
–	–	•	–	–

* Only for model Fieldshoot

Sauer 100 Dimensions & Weights

	Classic	Artemis
Weight Standard calibres	from 3050 g / 6.72 lbs	from 3080 g / 6.79 lbs
Weight Magnum calibres	from 3150 g / 6.94 lbs	from 3080 g / 6.79 lbs
Barrel length Standard calibres	560 mm / 22 inch	510 mm / 20 inch
Barrel length Magnum calibres	620 mm / 24 inch	560 mm / 22 inch
Overall length Standard calibres	1065 mm / 42 inch	980 mm / 39 inch
Overall length Magnum calibres	1125 mm / 44 inch	1030 mm / 41 inch

• serial configuration // ◦ optional // – not available // All information subject to change without notice.

Classic XT	Stainless XTA	Fieldshoot
from 3050 g / 6.72 lbs	from 3100 g / 6.83 lbs	from 4300 g / 9.47 lbs
from 3150 g / 6.94 lbs	from 3200 g / 7.05 lbs	from 4300 g / 9.47 lbs
560 mm / 22 inch	560 mm / 22 inch	620 mm / 24 inch
620 mm / 24 inch	620 mm / 24 inch	620 mm / 24 inch
1065 mm / 42 inch	1065 mm / 42 inch	1140 mm / 45 inch
1125 mm / 44 inch	1125 mm / 44 inch	1140 mm / 45 inch

Sauer 303 Serial Configuration

	Select	Artemis	Classic XT	Synchro XT
Receiver	aluminum	aluminum	aluminum	aluminum
Bolt	black	black	black	black
Receiver surface	black anodized	black anodized	black anodized	black anodized
Barrel surface	Nitrobond X	Nitrobond X	Nitrobond X	Nitrobond X
Barrel length	510 mm / 20 inch	510 mm / 20 inch	510 mm / 20 inch	510 mm / 20 inch
Muzzle-Ø	17 mm / 0.66 inch	17 mm / 0.66 inch	17 mm / 0.66 inch	17 mm / 0.66 inch
Sights	Open sights "Allround"	Open sights "Allround"	Contrast sights "Semi-Auto"	Contrast sights "Semi-Auto"
Muzzle thread	○	○	○	○
Trigger	Black Magic Trigger	Black Magic Trigger	Black Magic Trigger	Black Magic Trigger
Main stock	Ergo Lux	Ergo Compact	ErgoMax ambidextrous	Synchro XT Thumbhole stock ambidextrous
Butt plate (LOP = 365 mm / 14.37 inch)	15 mm / 0.59 inch	15 mm / 0.59 inch	15 mm / 0.59 inch	15 mm / 0.59 inch
Fore-end	drop	drop	drop	drop
Stock material	Walnut Grade 1, Laserline grain	Walnut Grade 1, Laserline grain	Polymer "grey"	Polymer "grey"
Magazine capacity Med./ Mag.	2	2	2	2
Magazine floor plate	aluminum, black anodized	aluminum, black anodized	aluminum, black anodized	aluminum, black anodized

• serial configuration // ○ optional // – not available // All information subject to change without notice.

Sauer 303 Barrels & Calibres

	Select	Artemis	Classic XT	Synchro XT
.308 Win., 510 mm / 20 inch	•	•	•	•
.30–06 Spring., 510 mm / 20 inch	•	•	•	•
8x57 IS, 510 mm / 20 inch	•	•	•	•

Sauer 303 Measures & Weights

	Select	Artemis	Classic XT	Synchro XT
Weight	from 3,470 g / 7.65 lbs	from 3,410 g / 7.5 lbs	from 3,630 g / 8.00 lbs	from 3,690 g / 8.14 lbs
Barrel length	510 mm / 20 inch	510 mm / 20 inch	510 mm / 20 inch	510 mm / 20 inch
Overall length	1,060 mm / 42 inch	1,045 mm / 41 inch	1,060 mm / 42 inch	1,060 mm / 42 inch

Sauer Semi-Automatic Shotguns Serial Configuration

	SL5 Semi-Automatic Shotgun
Calibre	12/76
Barrel length	700 mm (28 inch) / 760 mm (30 inch)
Overall length	1,240 mm (49 inch) / 1,300 mm (51 inch)
Weight	700 mm (28 inch): from 3 kg (6.61 lbs); 760 mm (30 inch): from 3.1 kg (6.83 lbs)
Proof tested	for Magnum Steel shot
Action	Inertia
Barrel	hard chrome bore
Magazine capacity	4 rounds in 12/70 – 3 rounds in 12/76
Purchased Chokes (incl.)	5 interchangeable choke tubes (Cylinder, Improved Cylinder, Modified, Improved Modified, Full) and black ABS Sauer Gun Case.

• serial configuration // ◦ optional // – not available // All information subject to change without notice.



Scan this QR code with your smartphone and browse through the latest version of the Sauer catalogue online. We hope you enjoy reading!

Your authorised Sauer dealer:

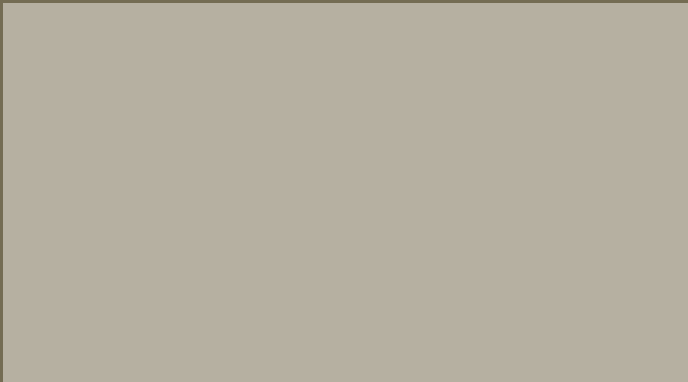

Please note: Catalogue images may vary from actual products. J.P. SAUER & SOHN GMBH reserves the right to make necessary technical changes without prior notice. Subject to errors and colour variations.

Firearms and ammunition can only be sold to permit holders. Please understand the legal regulations for the usage of silencers in your area and note that not every country allows their use.

J.P. SAUER & SOHN GMBH
Ziegelstadel 1
88316 Isny im Allgäu
Germany

Phone +49 7562 97554-0
Fax +49 7562 97554-801
www.sauer.de



Find us on Social Media

